

Customer :
Project Name :
Project No. :
Revision No. :

SPECIFICATION for INDUCTION MOTOR



0		For Bidding			
No.	DATE	DESCRIPTION	PREPARED BY	CHECKED BY	APPROVED BY



AC INDUCTION MOTOR DATA SHEET

IEEE841 TYPE

Catalog No.	IEEE250-12-L449TC-IBSH	Item No.	Rev. No. []
Project Name		Project No.	Quantity sets

GENERAL SPECIFICATION		PERFORMANCE DATA			
Frame Size	L449TC	Rated Output	190 kW 250 HP		
Type	PJP	Number of Poles	6		
Enclosure(Protection)	Totally Enclosed / IP55	Rotor Type	Squirrel Cage		
Method of Cooling	IC411(FC)	Starting Method*	D.O.L		
Rated Frequency	60 Hz	Rated Voltage	575 V	460 V	230 V
Number of Phases	3	Current	Full Load	237.1 A	296.3 A
Insulation Class	F		Locked-rotor**	680 %	680 %
Temp. Rise at full load (by resistance method)		Efficiency			
at 1.0 S.F	80 deg. C	50% Load		92.8 %	
Motor Location	<input type="checkbox"/> Indoor <input type="checkbox"/> Outdoor	75% Load		94.8 %	
Altitude	Less than 1,000 meter	100% Load		95.8 %	
Relative Humidity	Less than 80 %	Power Factor(p.u)			
Ambient Temp.	40 deg. C (Max.)	50% Load		0.690	
Duty Type	Continuous (S1)	75% Load		0.790	
Service Factor	1.15	100% Load		0.840	
Mounting	B35	Speed at Full Load	1185 r.p.m		
Bearing	Type	Anti-Friction	Torque		
	DE/N-DE	6322C3 / 6318C3-INS.	Full Load	1,129.6 lb.ft	
	Lubricant	Grease(Polyrex-EM)	Locked-rotor**	135 %	
External Thrust	Not applicable	Breakdown**	200 %		
Coupling Method	<input checked="" type="checkbox"/> Direct <input type="checkbox"/> V-belt	Moment of Inertia (J)			
Shaft Extension	Single	Load(Max.)	2,740.000 lb.ft2		
Terminal Box	Main	Cast Iron	Motor	158.295 lb.ft2	
	Aux.	Yes	Sound Pressure Level (No-load & mean value at 1m from motor)		
Location	Refer to Outline Drawing			80 dB(A)	
Application		Vibration		3.8 mm/sec (peak)	
Area classification	Hazardous	Permissible number of consecutive starts	Cold	2 times	
Type of Ex-Protection	Class I&II, Division 2		Hot	1 time	
Applicable Standard	IEEE841, NEMA MG1, CSA C390	Paint	Munsell No.	7.5BG6/1.5	

ACCESSORIES
*. Space Heater : 1EA/Motor

SUBMITTAL DRAWING		
Outline Dimension Drawing	Motor Weight(Approx.)	
B35	LM-I044XC4UE001	2990 lb.

SPARE PARTS

REMARK				
1. Premium efficiency according to NEMA MG1				
2. Inverter Duty @ 1.0 Service Factor & F Temperature rise				
-. 10:1 VT (20:1 VT at 50% load)				
-. 10:1 CT				
-. CHp up to 1.5 times base speed, NEMA MG1 Part31				
3. NDE side : Insulated bearing				
4. CSA Certification				
-. Class I, Division 2, Group A, B, C & D; Temp code : T3				
-. Class II, Division 2 Group F & G; Temp code : T3				
5. Shaft material : AISI4140				
Date	DSND	CHKD	CHKD	APPD
2024-07-13	S.H. Lee	I.K. Kim	R.G. Kim	S.W. Kim

[Note] Others not mentioned in this data sheet shall be in accordance with maker standard.
 Above technical data are only design values and shall be guaranteed with tolerance of applicable standard.
 Inspection and performance test shall be done according to maker standard, if not mentioned.
 * In case of Inverter-Fed Motor, performance data is based on sine wave tests. It may be different from test data of Inverter combined motor.
 ** Data is based on rated voltage & frequency and is expressed as a percentage of full-load value.

1	2	3	4
REV	DATE	CONTENTS	REVD BY CHKD BY CHKD BY APPD BY

4.72



CROWN TRITON
Premium Efficiency AC 3 Phase Motor



250HP	6P	460V	Cat. No.	IEEE250-12-L449TC-IBSH			
Model	LATER		INS. Class	F	Amps	296.3	
Type	PJP	Duty	CONT	Code	H	Amb. 40°C	
Frame	L449TC	Encl.	TEFC	S.F.	1.15	RPM 1185	
Bearing	Drive	6322C3		S.F.1.00 (10:1 C.T., 20:1 V.T., NEMA-MG1 Part31)		3/4 Eff. 94.8%	
	Opp.	6318C3-INS.				NEMA Design B Torque	
Usable at							
CSA Certified for	CLASS I, Div. 2, Gr. A, B, C & D		CLASS II, Div. 2, Gr. F & G		Temp. Code (sine wave)	Frame L440FR - 500FR	
	CLASS I, Zone 2, Gr. IIA, IIB, & IIC					Amb. 40°C	T3 (200°C)
						Amb. 55°C	T3 (200°C)
No.	-	Date	-	Weight	2990 lb		

IEEE Std 841-2021

4M-136054

MARINE DUTY IEEE45

Made in Korea H1



2.36

APPD BY	S.Y.KIM	UNIT	INCH	SUBJECT	CSA Class I, Division2 IEEE841 (XL)	DWG SIZE
CHKD BY	I.K.KIM	SCALE	NONE			A4 (1:1)
CHKD BY	R.G.KIM	PROJEC'N	3rd Angle	TITLE NAMEPLATE DRAWING		
DSND BY	S.H.LEE	DATE	2024.06.07			
				REF. NO	4M-136054	Sheet No. of
				DWG NO	NP-IEEE250-12-L449TC-IBSH	Revision No. 0

Type :	PJP
Full Load Torque :	1129.6 lb.ft
Load moment of Inertia (J) :	2740.000 lb.ft ²
Motor moment of Inertia (J) :	158.295 lb.ft ²

190kW 250HP	6 P	60 Hz
Speed at Full Load :		1185 RPM
Rated Voltage	575V	460V 230V
Full Load Current	237.1A	296.3A 592.7A

SPEED VS TORQUE & CURRENT CURVE

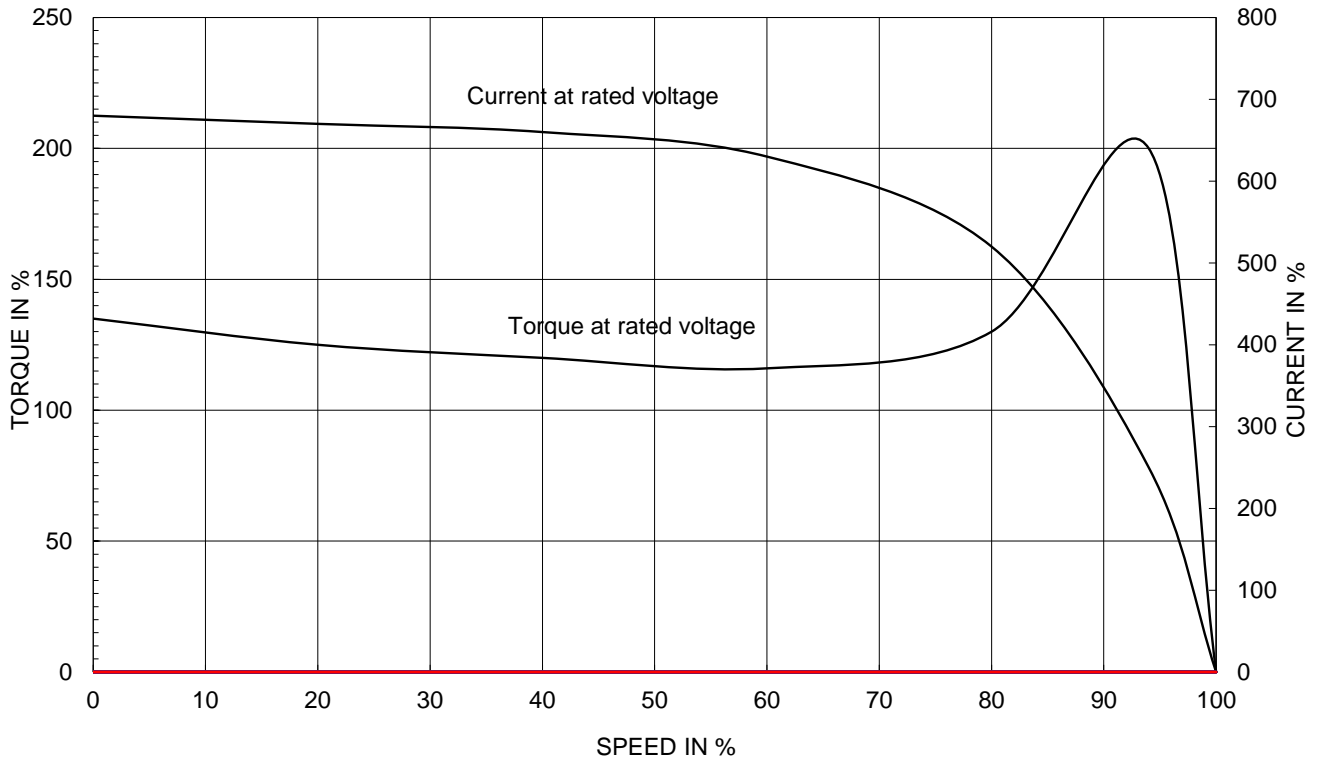

OUTPUT VS EFF., P.F & CURRENT CURVE

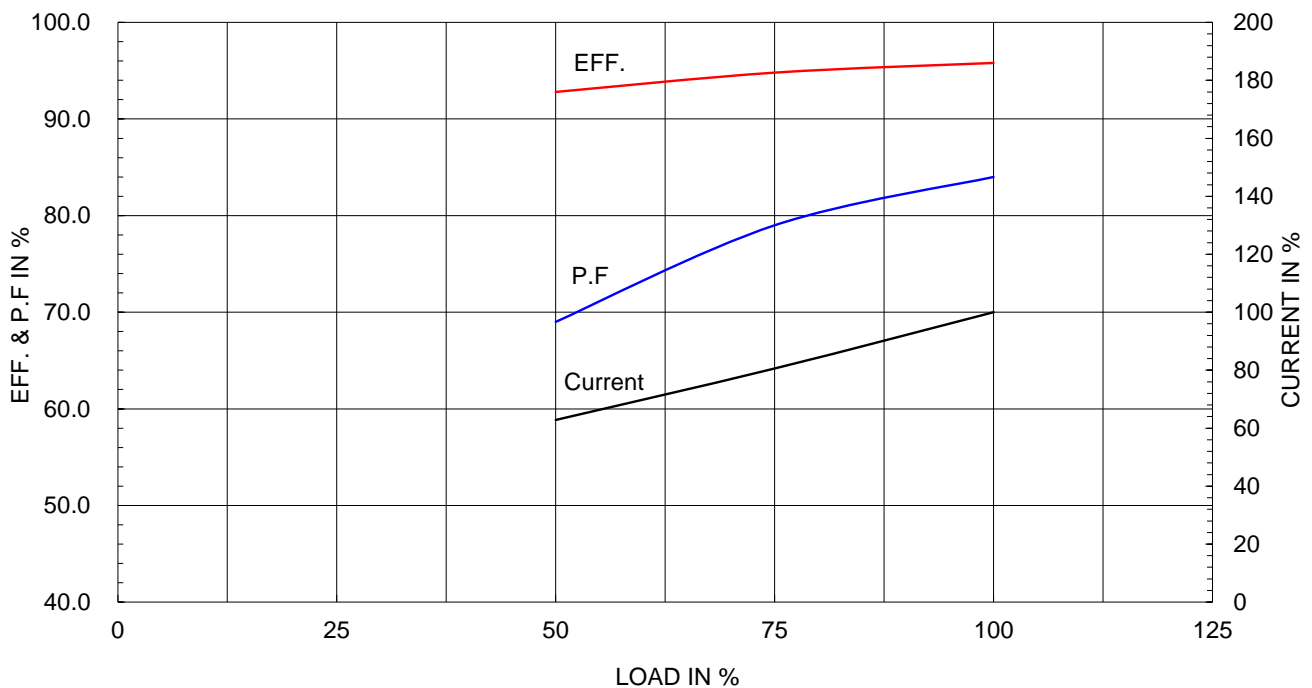

1	2	3	4
▽	50S	REV	DATE
▽▽	12.5S		CONTENTS
▽▽▽	3.2S		REVD BY
▽▽▽▽	0.4S		CHKD BY
			CHKD BY
			APPD BY

IEEE841

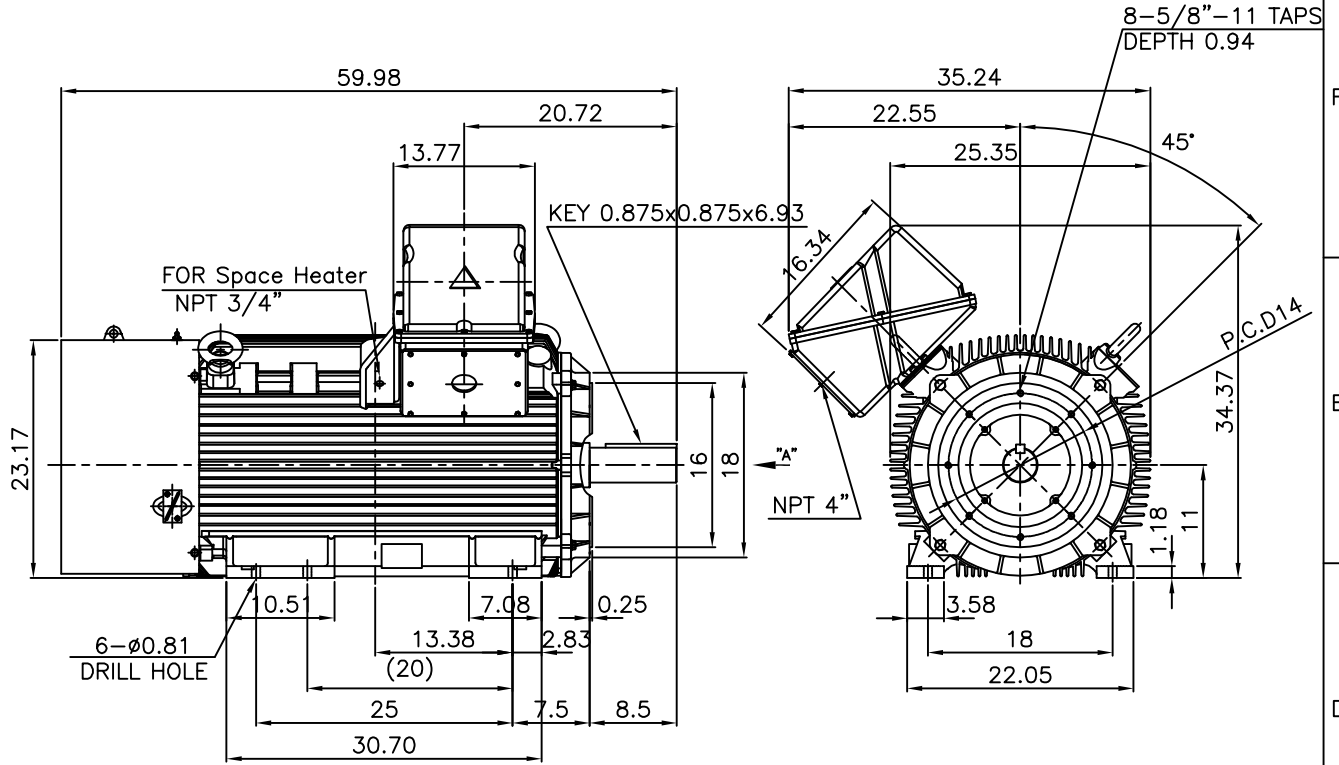

NOTE

1.TOLERANCE :

CENTER HEIGHT	11	+0.000	-0.060
RABBET DIAMETER	ø16	0	-0.005
SHAFT DIAMETER	ø3.375	+0.000	-0.001
KEYWAY WIDTH	0.875	+0.003	-0.000

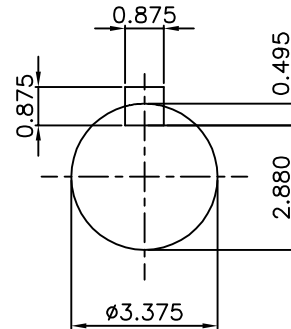

VIEW "A"

APPD BY	S.Y.KIM	UNIT	INCH	SUBJECT	Fr.L449TC	DWG SIZE	A4 (1:18)
CHKD BY	O.J.KIM	SCALE	1/18	TITLE	NEMA STD SHAFT(4140 SHAFT)		
CHKD BY	R.G.KIM	PROJEC'N	3각법(3rd Angle)	OUTLINE			
DSND BY	H.K.LEE	DATE	2021-04-27				
				REF. NO		Sheet No.	of
				DWG NO	LM-1044XC4UE001	Revision No.	0