

Customer :
Project Name :
Project No. :
Revision No. :

SPECIFICATION for INDUCTION MOTOR



0		For Bidding			
No.	DATE	DESCRIPTION	PREPARED BY	CHECKED BY	APPROVED BY



AC INDUCTION MOTOR DATA SHEET

IEEE841 TYPE

Catalog No.	IEEE25-36-284TSC	Item No.	Rev. No.	[]
Project Name		Project No.	Quantity	sets

GENERAL SPECIFICATION			PERFORMANCE DATA			
Frame Size	284TSC	Rated Output	18.5 kW		25 HP	
Type	PJP	Number of Poles	2			
Enclosure(Protection)	Totally Enclosed / IP55	Rotor Type	Squirrel Cage			
Method of Cooling	IC411(FC)	Starting Method*	D.O.L			
Rated Frequency	60 Hz	Rated Voltage	575 V	460 V	230 V	
Number of Phases	3	Current	Full Load	22.8 A	28.5 A	56.9 A
Insulation Class	F		Locked-rotor**	670 %	670 %	670 %
Temp. Rise at full load (by resistance method)		Efficiency				
at 1.0 S.F	80 deg. C	50% Load		88.7 %		
Motor Location	<input type="checkbox"/> Indoor <input type="checkbox"/> Outdoor	75% Load		90.7 %		
Altitude	Less than 1,000 meter	100% Load		91.7 %		
Relative Humidity	Less than 80 %	Power Factor(p.u)				
Ambient Temp.	40 deg. C (Max.)	50% Load		0.740		
Duty Type	Continuous (S1)	75% Load		0.840		
Service Factor	1.15	100% Load		0.890		
Mounting	B35	Speed at Full Load		3560 r.p.m		
Bearing	Type	Anti-Friction		Torque		
	DE/N-DE	6310ZC3 / 6310ZC3		Full Load	36.6 lb.ft	
	Lubricant	Grease(Polyrex-EM)		Locked-rotor**	160 %	
External Thrust	Not applicable		Breakdown**	230 %		
Coupling Method	<input checked="" type="checkbox"/> Direct <input type="checkbox"/> V-belt	Moment of Inertia (J)				
Shaft Extension	Single	Load(Max.)		24.985 lb.ft2		
Terminal Box	Main	Cast Iron		Motor		1.899 lb.ft2
	Aux.	No		Sound Pressure Level (No-load & mean value at 1m from motor)		
Location	Refer to Outline Drawing		82 dB(A)			
Application		Vibration		3.8 mm/sec (peak)		
Area classification	Hazardous	Permissible number of consecutive starts		Cold	3 times	
Type of Ex-Protection	Class I&II, Division 2			Hot	2 times	
Applicable Standard	IEEE841, NEMA MG1, CSA C390	Paint	Munsell No.	7.5BG6/1.5		

ACCESSORIES

SUBMITTAL DRAWING		
Outline Dimension Drawing	Motor Weight(Approx.)	
B35	LM-I1284C4CL001	380 lb.

REMARK







1. Premium efficiency according to NEMA MG1
2. Inverter Duty @ 1.0 Service Factor & F Temperature rise
 - 10:1 VT (20:1 VT at 50% load)
 - 10:1 CT
 - CHP up to 1.5 times base speed, NEMA MG1 Part31
3. CSA Certification
 - Class I, Division 2, Group A, B, C & D
 - Class II, Division 2 Group E, F & G (Group E : up to 320Fr.)
4. Service Factor 1.15 and Temperature rise B are applicable under the condition of sine wave power.
5. Service Factor 1.25 is applicable to motors of 100HP or less with temperature rise F & Non-Hazardous.

Date	DSND	CHKD	CHKD	APPD
2024-07-13	S.H. Lee	I.K. Kim	R.G. Kim	S.W. Kim

[Note] Others not mentioned in this data sheet shall be in accordance with maker standard.
 Above technical data are only design values and shall be guaranteed with tolerance of applicable standard.
 Inspection and performance test shall be done according to maker standard, if not mentioned.
 * In case of Inverter-Fed Motor, performance data is based on sine wave tests. It may be different from test data of Inverter combined motor.
 ** Data is based on rated voltage & frequency and is expressed as a percentage of full-load value.

1	2	3	4
REV	DATE	CONTENTS	REVD BY

4.72

25HP	2P	460V	Cat. No.	IEEE25-36-284TSC				
Model	HLS284PR13		INS. Class	F	HD-F1	Amps	28.5	
Type	HLS	Duty	CONT	Code	G	Amb.	40°C	
Frame	284TSC	Encl.	TEFC	S.F.	1.15	RPM	3560	
Bearing	Drive	6310ZC3		S.F.1.00 (10:1 C.T., 20:1 V.T., NEMA-MG1 Part31)		3/4 Eff.	90.7%	
	Opp.	6310ZC3				NEMA Design	B	
Usable at	50Hz 20HP 380V 31.7A 2960rpm S.F.: 1.0 Eff.: 90.3% Code: H							
	50Hz 20HP 400/415V 30.6/30.1A 2965/2965rpm S.F.: 1.0 Eff.: 90.3/90.3% Code: H/J							
CSA Certified for	Model	LATER		Type	PJP			
	CLASS I, Div. 2, Gr. A, B, C & D CLASS I, Zone 2, Gr. IIA, IIB, & IIC	CLASS II, Div. 2, Gr. E, F & G (Gr. E : Up to 320FR)		Temp. Code (sine wave)	Frame	140~320FR	360~400FR	440FR
		Amb. 40°C	T3C (160°C)		T3B (165°C)	T3A (180°C)		
Amb. 55°C	T3A (180°C)	T3A (180°C)	T3 (200°C)					
No.	-		Date	-		Weight	380 lb	

IEEE Std 841-2021

4M-135701

MARINE DUTY IEEE45

Made in Korea H1



2.36

APPD BY	S.Y.KIM	UNIT	INCH	SUBJECT	CSA Class I, Division2 IEEE841 (HL)	DWG SIZE
CHKD BY	I.K.KIM	SCALE	NONE			A4 (1:1)
CHKD BY	R.G.KIM	PROJEC'N	3rd Angle	TITLE NAMEPLATE DRAWING		
DSND BY	S.H.LEE	DATE	2024.06.07			
				REF. NO	4M-135701	Sheet No. of
				DWG NO	NP-IEEE25-36-284TSC	Revision No. 0



PERFORMANCE CURVE

CURVE NO.

PC-IEEE25-36-284TSC

Type :	PJP
Full Load Torque :	36.6 lb.ft
Load moment of Inertia (J) :	24.985 lb.ft2
Motor moment of Inertia (J) :	1.899 lb.ft2

18.5kW 25HP	2 P	60 Hz
Speed at Full Load :		3560 RPM
Rated Voltage	575V	460V 230V
Full Load Current	22.8A	28.5A 56.9A

SPEED VS TORQUE & CURRENT CURVE

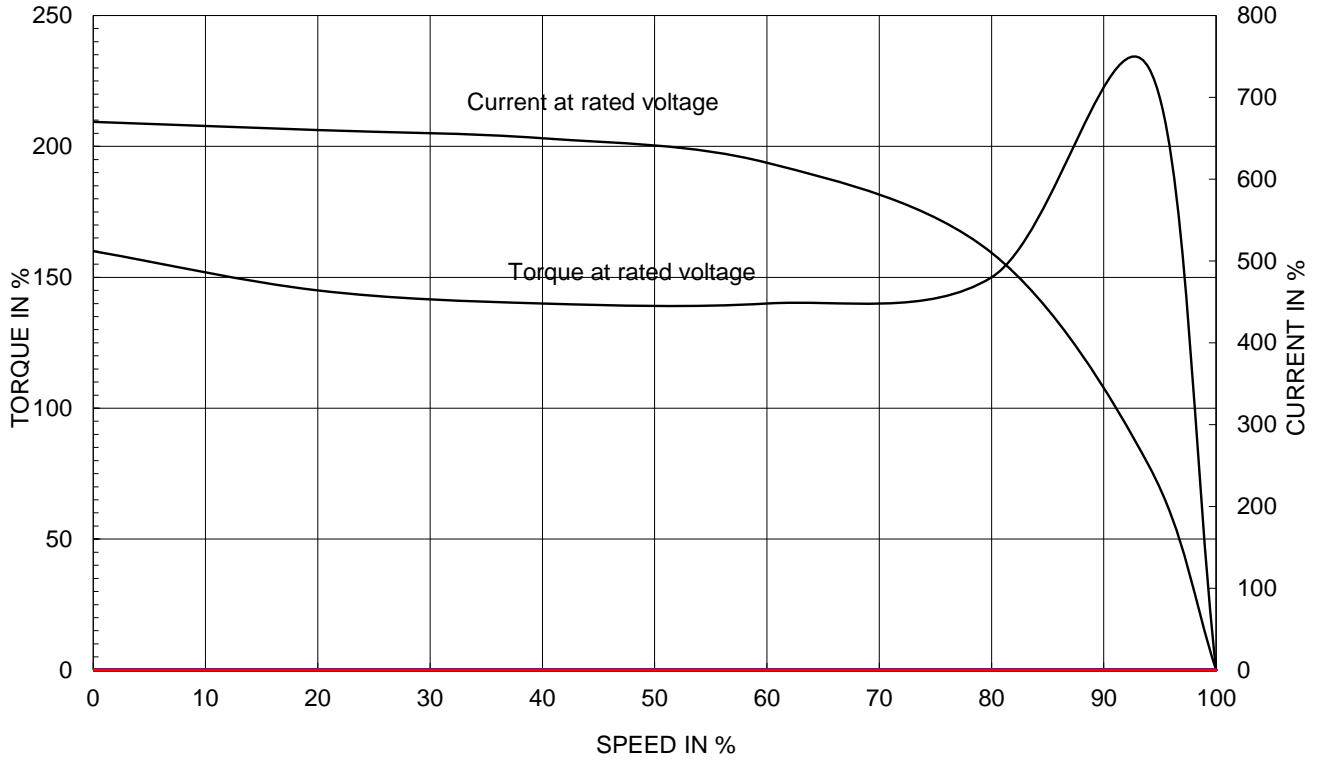

OUTPUT VS EFF., P.F & CURRENT CURVE

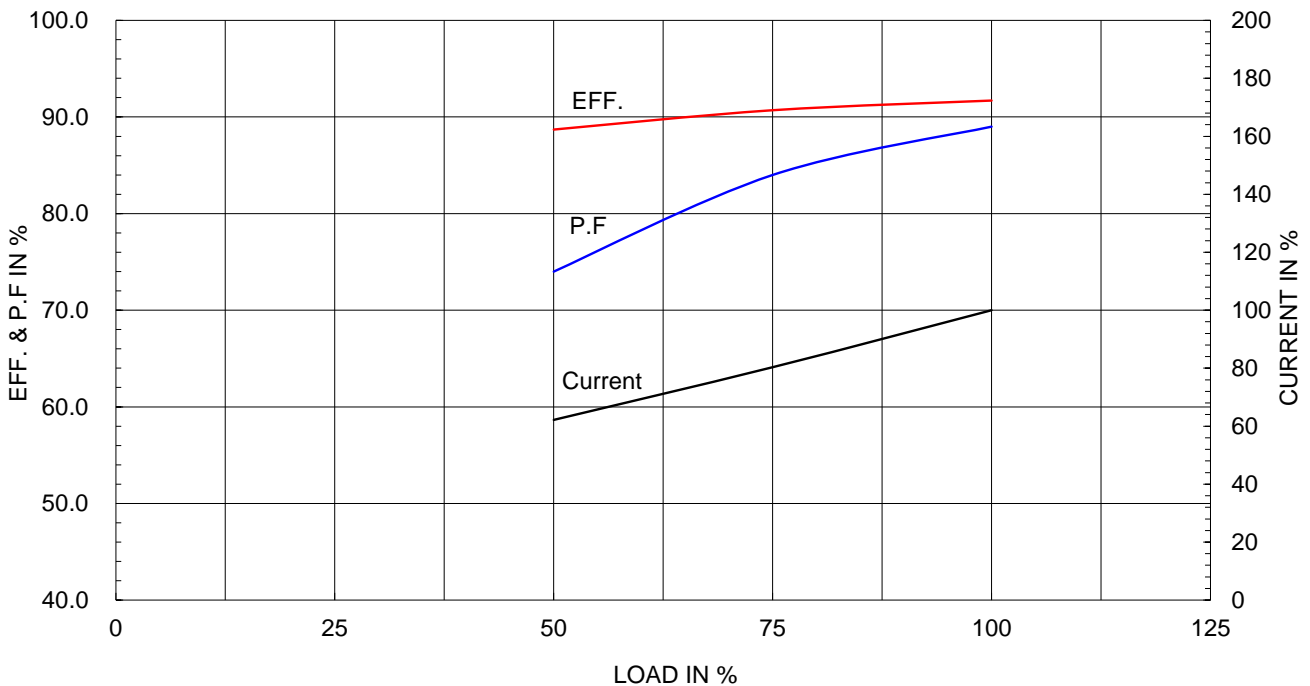

본 도면은 HD현대일렉트릭(주) 재산이며 허가없이 복사할 수 없음 (취급유의)

THIS DRAWING IS PROPRIETARY TO HYUNDAI ELECTRIC. NO PART OF THIS DRAWING MAYBE REPRODUCED WITHOUT THE PERMISSION OF HYUNDAI ELECTRIC.

▽	50S	REV	DATE	CONTENTS	REVD BY	CHKD BY	CHKD BY	APPD BY
▽▽	12.5S							
▽▽▽	3.2S							
▽▽▽▽	0.4S							

IEEE841

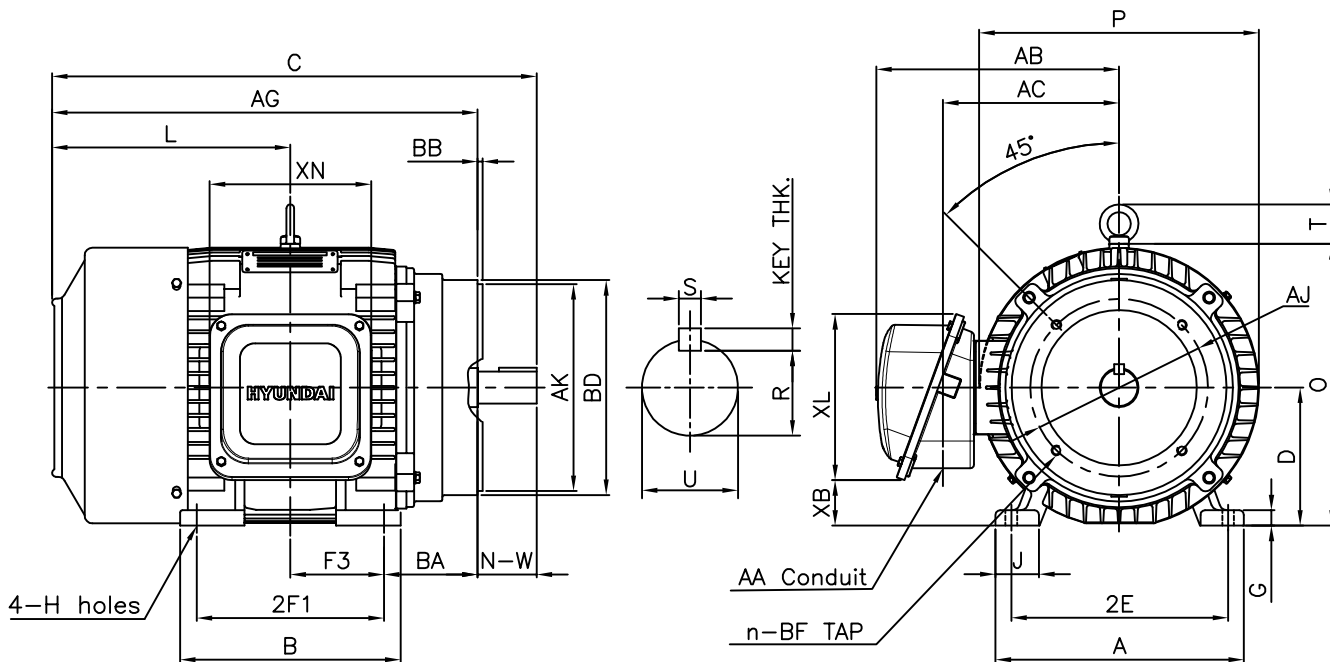

DIMENSIONS

Unit : inch

F L A N G E						M O U N T I N G								
AJ	AK	BD	BB	BF	n	A	B	2E	2F1	2F2	F3	G	J	H
9.00	10.50	10.9	0.25	1/2-13	4	12.60	11.18	11.00	9.50	-	4.75	0.78	2.20	0.53

C O N D U I T B O X						O V E R A L L								APPROX. WGT.(LB)
AA	AB	AC	XB	XL	XN	AG	BA	C	D	L	O	P	T	
1.50	12.44	9.06	3.39	8.43	8.19	21.40	4.75	24.65	7.00	12.12	14.28	14.19	2.01	380

S H A F T					KEY THK.	B E A R I N G	
U	N-W	KEYWAY				DRIVE END	OPP. DRIVE END
		R	ES	S			
1.625	3.25	1.416	1.91	0.375	0.375	6310ZC3	6310ZC3

NOTE

- 1.Dimension "D" tolerance : +0.00inch - 0.03inch
- 2.Dimension "U" tolerance : +0.000inch - 0.0005inch
- 3.Dimension "R" tolerance : +0.000inch - 0.015inch

APPD BY	S.Y.KIM	UNIT	INCH	SUBJECT	NEMA 284TSC	DWG SIZE	A4 (1:1)
CHKD BY	R.G.KIM	SCALE	NONE				
CHKD BY	Y.H.BAE	PROJEC'N	3각법(3rd Angle)	TITLE OUTLINE			
DSND BY	H.K.LEE	DATE	2021-05-06				
				REF. NO	350A8309BA	Sheet No.	of
				DWG NO	LM-I1284C4CL001	Revision No.	0



Cls. I&II, Div. 2 IEEE 841



▽	50S
▽▽	12.5S
▽▽▽	3.2S
▽▽▽▽	0.4S

REV	DATE	CONTENTS	REVD BY	CHKD BY	CHKD BY	APPD BY

일반가공공차		일반제관공차	
1-4	±0.1	6-30	±0.5
4-18	±0.2	30-120	±0.8
18-63	±0.3	120-315	±1.2
63-250	±0.5	315-1000	±2.0
250-	±0.8	1000-	±3.0

Q'TY	DESCRIPTION	MATERIAL	DIMENSION	WEIGHT	PART NO.	REMARK	NO.
APPD BY	S.Y.KIM	UNIT	inch(mm)	SUBJECT	FR. 250-280 (CAST IRON)	DWG SIZE	
CHKD BY		SCALE	1/2	TITLE		A3 (1:2)	
CHKD BY	R.G.KIM	PROJEC'N	3rd Angle	TERMINAL BOX ASS'Y			
DSND BY	배승희	DATE	2023-10-19	REF. NO		Sheet No.	of
				DWG NO	3M-248458	Revision No.	0